

RL9000TWM Series

Tank, Hopper and Vessel Weighing Assembly



Picture is a representation of actual product.

The RL9000TWM Series stainless steel weigh module is ideal for use in tank, hopper, vessel and many other applications. The low-profile design offers an economical solution in a competitive marketplace. This rugged, high-precision mount is designed for easy installation and does not require check rods or other stabilizing hardware. The stainless steel construction and welded-seal offer additional protection in washdown areas.

Load Cell Specifications

Full Scale Output:

3 (\pm 0.1%) mV/V

Bridge Resistance:

350 ohms

Material/Finish:

Stainless steel

Safe Overload:

150% full scale

Rated Excitation:

5-10VDC

Operating Temperature:

0° F to 150° F

Insulation Resistance:

5,000 megohms

Non-linearity:

1 k-100 k 0.05% FS
150 k-450 k 0.1% FS

Non-repeatability:

1 k-100 k 0.02% FS
150 k-450 k 0.03% FS

Seal Type:

Welded seal IP67

Cable Length:

25 ft

Cable Color Code:

Green+ Excitation
Black.....- Excitation
White+ Signal
Red- Signal

Warranty:

Two-year limited warranty



Assembly with integral
RL9000TWM compression disk load cell.

Standard Features

- Capacities: 1,000 lb-450,000 lb
- Very low profile design
- 3mV/V output
- Self-centering
- Self-checking assembly
- Offers 100% sideload, 100% uplift and 150% static safe load and 300% ultimate static overload protection
- Stainless steel construction
- Welded seal
- Weighs accurately with as much as a 3° non-parallel load
- Includes 25 ft load cell cable

Applications

- Tank, hopper or vessel weighing

Optional Features

- Stainless steel top plates (150,000 lb-450,000 lb have mild steel painted base plate)

Complete Kit Includes

- One JB4SS NEMA Type 4X stainless steel signal trim junction box
- Three or four stainless steel mounting assemblies
- 25 ft of our hostile environment EL147HE SURVIVOR® load cell cable

Load Cell Certifications



RL9000TWM Series

Tank, Hopper and Vessel Weighing Assembly

Order Information

Load Rating (Per Module)	Part #	Price
Single Module		
1,000 lb	84353	Consult
2,500 lb	84354	Consult
5,000 lb	84355	Consult
10,000 lb	84356	Consult
15,000 lb	84357	Consult
20,000 lb	84358	Consult
25,000 lb	84359	Consult
35,000 lb	84360	Consult
50,000 lb	84361	Consult
60,000 lb	84362	Consult
75,000 lb	84363	Consult
100,000 lb	84364	Consult
150,000 lb	84365	Consult
200,000 lb	84366	Consult
250,000 lb	84368	Consult
300,000 lb	84369	Consult
400,000 lb	84370	Consult
450,000 lb	84371	Consult
3-Module Kit		
1,000 lb	98974	Consult
2,500 lb	98980	Consult
5,000 lb	98981	Consult
10,000 lb	98982	Consult
15,000 lb	98983	Consult
20,000 lb	98984	Consult
25,000 lb	98985	Consult
35,000 lb	98986	Consult
50,000 lb	98987	Consult
60,000 lb	98988	Consult
75,000 lb	98989	Consult
100,000 lb	98990	Consult
150,000 lb	98991	Consult
200,000 lb	98992	Consult
250,000 lb	98993	Consult
300,000 lb	98994	Consult
400,000 lb	98995	Consult
450,000 lb	98996	Consult
4-Module Kit		
1,000 lb	98997	Consult
2,500 lb	98998	Consult
5,000 lb	98999	Consult
10,000 lb	99000	Consult
15,000 lb	99001	Consult
20,000 lb	99002	Consult
25,000 lb	99003	Consult
35,000 lb	99004	Consult
50,000 lb	99005	Consult
60,000 lb	99006	Consult
75,000 lb	99007	Consult
100,000 lb	99008	Consult
150,000 lb	99009	Consult
200,000 lb	99010	Consult
250,000 lb	99011	Consult
300,000 lb	99012	Consult
400,000 lb	99013	Consult
450,000 lb	99014	Consult

150,000 lb-450,000 lb have mild steel painted base plates

Load Rating (Per Module)	Part #	Price
Top Plates (Stainless Steel) with bolts		
1,000 lb-15,000 lb	91207	Consult
20,000 lb-50,000 lb	91210	Consult
60,000 lb-100,000 lb	91211	Consult
150,000 lb-200,000 lb	91213	Consult
250,000 lb-450,000 lb	91215	Consult
Top Plates (Mild Steel) with bolts		
1,000 lb-15,000 lb	124758	Consult
20,000 lb-50,000 lb	125141	Consult
60,000 lb-100,000 lb	124759	Consult
150,000 lb-200,000 lb	124760	Consult
250,000 lb-450,000 lb	124761	Consult
Dummy Weigh Modules (non-functioning)		
1,000 lb-10,000 lb	158749	Consult
15,000 lb	158750	Consult
20,000 lb-50,000 lb	158752	Consult
60,000 lb-100,000 lb	158753	Consult
150,000 lb-200,000 lb	158754	Consult
250,000 lb-450,000 lb	158755	Consult

150,000 lb-450,000 lb have mild steel painted base plates

Shims* - Order Information

Capacity	Thickness	Material	Part #	Price
Shims				
1,000 lb-15,000 lb	0.0625	SST	167001	Consult
1,000 lb-15,000 lb	0.125	SST	167002	Consult
1,000 lb-15,000 lb	0.250	SST	167003	Consult
1,000 lb-15,000 lb	0.0625	MS	167004	Consult
1,000 lb-15,000 lb	0.125	MS	167005	Consult
1,000 lb-15,000 lb	0.250	MS	167006	Consult
20,000 lb-50,000 lb	0.0625	SST	167008	Consult
20,000 lb-50,000 lb	0.125	SST	167009	Consult
20,000 lb-50,000 lb	0.250	SST	167010	Consult
20,000 lb-50,000 lb	0.0625	MS	167011	Consult
20,000 lb-50,000 lb	0.125	MS	167012	Consult
20,000 lb-50,000 lb	0.250	MS	167013	Consult
60,000 lb-100,000 lb	0.0625	SST	167014	Consult
60,000 lb-100,000 lb	0.125	SST	167015	Consult
60,000 lb-100,000 lb	0.250	SST	167016	Consult
150,000 lb-200,000 lb	0.0625	SST	167020	Consult
150,000 lb-200,000 lb	0.125	SST	167021	Consult
150,000 lb-200,000 lb	0.250	SST	167022	Consult
250,000 lb-450,000 lb	0.0625	SST	167026	Consult
250,000 lb-450,000 lb	0.125	SST	167027	Consult
250,000 lb-450,000 lb	0.250	SST	167028	Consult

SST Stainless steel MS Mild steel

*Shims match dimensions of base plate and optional top plate

RL9000TWM Series

Tank, Hopper and Vessel Weighing Assembly

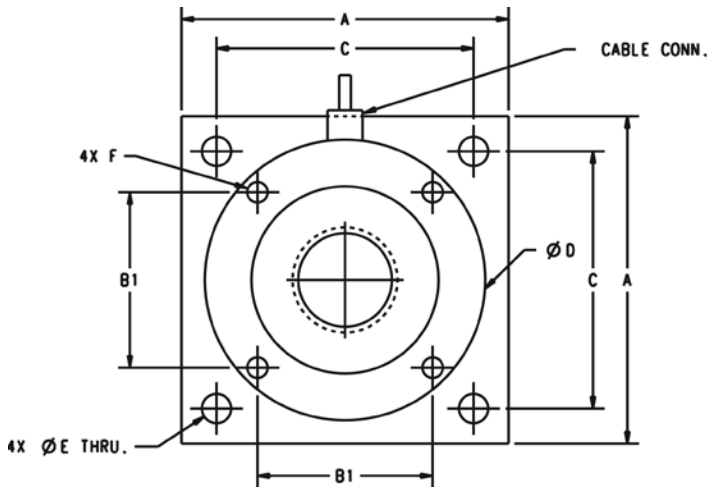

Dimensions (inches)

Rated Capacity lb/in	A	B1	C	D	E	F	G	H	I	Conduit Adapter
1,000-10,000	4.00	2.00	3.25	3.50	0.40	3/8-16 UNC	1.35	0.375	0.75	N/A
15,000	4.00	2.00	3.25	3.50	0.40	3/8-16 UNC	1.60	0.625	0.75	N/A
20,000-50,000	7.00	3.75	5.50	6.00	0.63	1/2-13 UNC	2.48	0.75	1.30	1/2-14 NPT
60,000-100,000	8.00	4.25	6.50	7.00	0.81	3/4-16 UNC	2.50	1.00	1.30	1/2-14 NPT

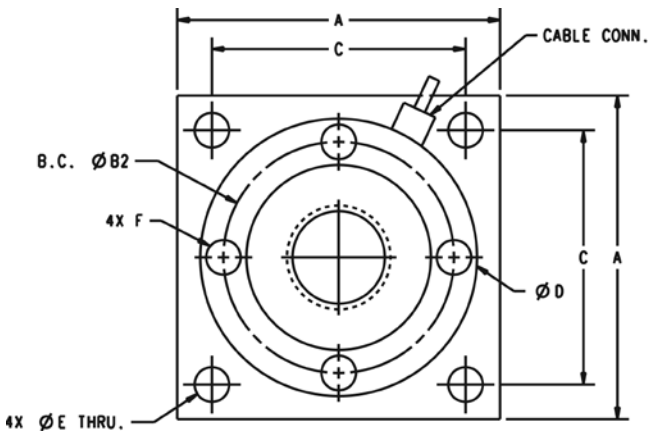

Dimensions (inches)

Rated Capacity lb/in	A	B2	C	D	E	F	G	H	I	Conduit Adapter
150,000-200,000	10.0	7.825	8.00	9.00	1.10	1-14 UNF	4.75	2.00	1.70	1/2-14 NPT

RL9000TWM Series

Tank, Hopper and Vessel Weighing Assembly

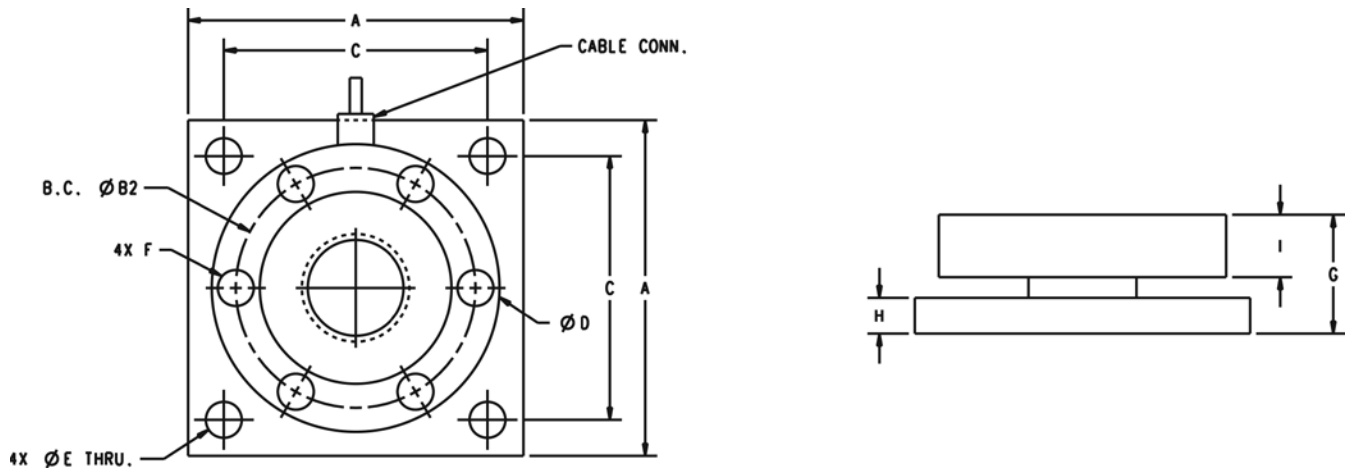
**Dimensions**

Rated Capacity lb/in	A	B2	C	D	E	F	G	H	I	Conduit Adapter
250,000-450,000	11.00	7.75	9.00	9.00	1.30	7/8-14 UNF	6.42	3.00	2.25	1/2-14 NPT

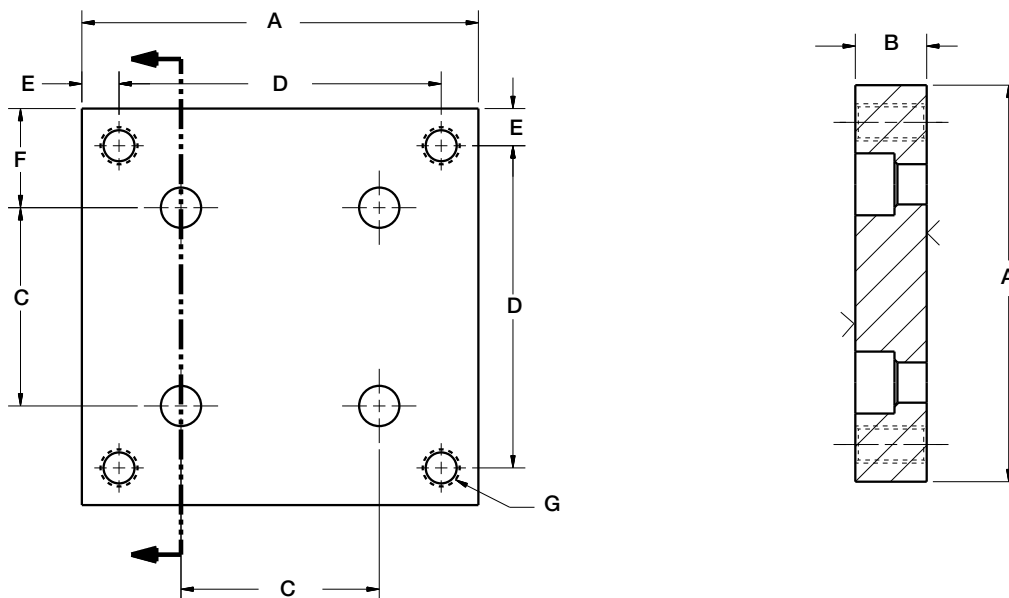
Optional Top Plates**Dimensions**

Rated Capacity lb/in	A	B	C	D	E	F	G
1,000-15,000	4.00	0.72	2.00	3.25	0.38	1.00	3/8-16 UNC
20,000-50,000	7.00	0.97	3.75	5.50	0.75	1.62	5/8-11 UNC
60,000-100,000	8.00	1.46	4.25	6.50	0.75	1.88	3/4-16 UNF
150,000-200,000	10.00	1.94	5.53	8.00	1.00	2.25	1-14 UNS
250,000-450,000	11.00	2.94	7.75 B.C.	9.00	1.00	1.00	1-1/4-12 UNF